

# DOREL HOME FURNISHINGS CANADA

---

## TWIN BED

Model No.:

DA6108WC      WHITE

UPC CODE:

0-29986-61083-6      WHITE

NOTE:

THIS INSTRUCTION BOOKLET  
CONTAINS **IMPORTANT** SAFETY  
INFORMATION. PLEASE READ AND  
KEEP FOR FUTURE REFERENCE.

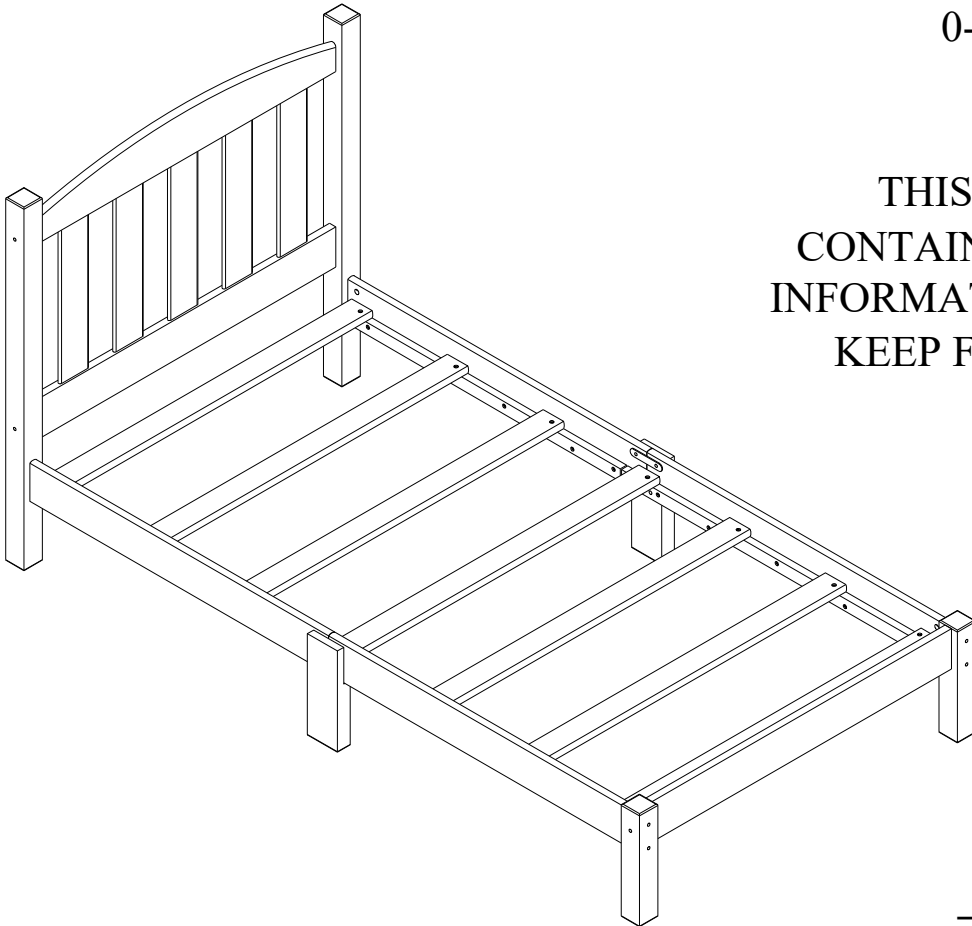

Lot number:

(TAKEN FROM CARTON)

---

Date of purchase:

\_\_\_\_ / \_\_\_\_ / \_\_\_\_

**DO NOT RETURN PRODUCT TO THE STORE.**

If a part is missing or damaged, contact our customer service department. We will replace the part **FREE** of charge.



Tel # : 1-800-295-1980  
E-Mail: [das@dorel.com](mailto:das@dorel.com)  
Fax #: 514-353-7819

## CUSTOMER SERVICE

If you are missing parts or have any questions about this product, contact our customer service representative first!

 **CALL 1-800-295-1980**

You can also order parts by writing to the address listed below. Please include the product model number, color and a detailed description of the part.

**Customer Service Department No. 413  
12345 Albert-Hudon Boulevard, Suite 100  
Montreal, Quebec  
Canada, H1G 3L1**

**E-MAIL: [das@dorel.com](mailto:das@dorel.com)**

## NOTES

- \* Ensure all parts and components are present before beginning assembly.
- \* Assemble on a soft, smooth surface to prevent damage to the product finish.
- \* Read all instructions before use.
- \* A Phillips head screw driver is not included.
- \* **DO NOT** use power tools.
- \* **CAUTION:** Adult assembly required.
- \* Assembly may require two people.
- \* Estimated assembly time: 30 minutes.

## CARE AND CLEANING

Dust regularly with a soft, lint-free cloth to prevent soil build-up. A damp cloth may be used occasionally to clean surface. Dry immediately. Do not use any abrasives that may damage finish. Excessive exposure to sunlight and extreme changes in temperature and moisture can damage wood furniture.

## MAINTENANCE

Check bolts/screws periodically and tighten them if necessary.

## LIMITED WARRANTY



Dorel Home Furnishings warrants its product to be free from defects in material and workmanship and agrees to remedy any such defect. This warranty covers 1 year from the date of original purchase. This warranty is valid only upon presentation of proof of purchase. This is solely limited to the repair or replacement of defective furniture components and no assembly labor is included. This warranty does not apply to any product which has been improperly assembled, subjected to misuse or abuse or which has been altered or repaired in any way. This warranty gives you specific legal rights and you may also have other rights which vary from Province to Province.



**WARNING: Should this product become damaged, and/or components are broken or missing, DO NOT USE.**



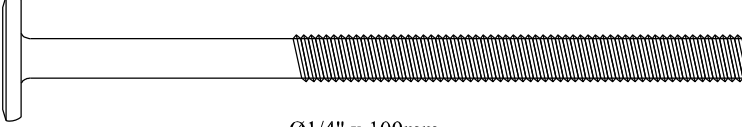
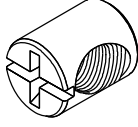
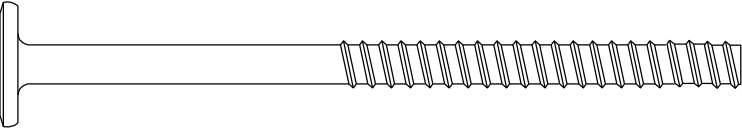
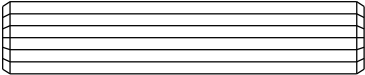
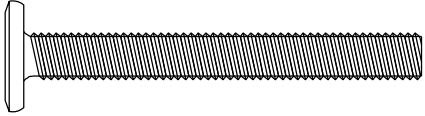
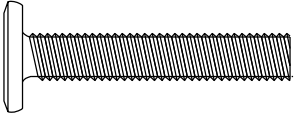

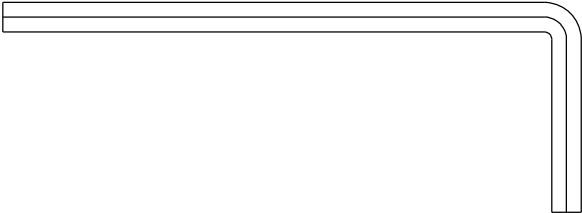
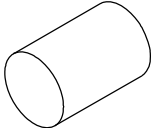
# TWIN BED DA6108WC

## HARDWARE LIST

1	 <p>Ø1/4" x 100mm</p>	2	 <p>Ø11.8mm x 15mm</p>	
<p>JOINT CONNECTOR (4mm HEX HEAD) 8 PCS</p>		<p>BARREL NUT 8 PCS</p>		
3	 <p>Ø6.5mm x 100mm</p>	4	 <p>Ø10mm x 50mm</p>	
<p>WOOD JOINT CONNECTOR (4mm HEX HEAD) 6 PCS</p>		<p>WOOD DOWEL 12 PCS</p>		
5	 <p>Ø1/4" x 55mm</p>	6	 <p>Ø1/4" x 37mm</p>	
<p>JOINT CONNECTOR (4mm HEX HEAD) 4 PCS</p>		<p>JOINT CONNECTOR (4mm HEX HEAD) 4 PCS</p>		
7	 <p>20mm x 100mm</p>		8	 <p>Ø4mm x 35mm</p>
<p>METAL PLATE 2 PCS</p>			<p>FLAT HEAD SCREW 14 PCS</p>	
9			10	
<p>ALLEN KEY 1 PC</p>			<p>STOPPER 5 PCS</p>	

# TWIN BED DA6108WC

## PARTS LIST

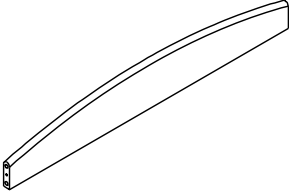
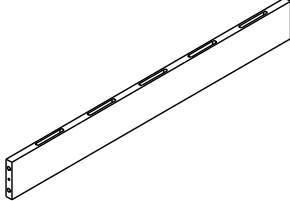
A		B		C	
HEADBOARD LEFT POST 1 PC		HEADBOARD RIGHT POST 1 PC		FOOTBOARD LEFT POST 1 PC	
D		E		F	
FOOTBOARD RIGHT POST 1 PC		TOP CROSS 1 PC		BOTTOM CROSS 1 PC	

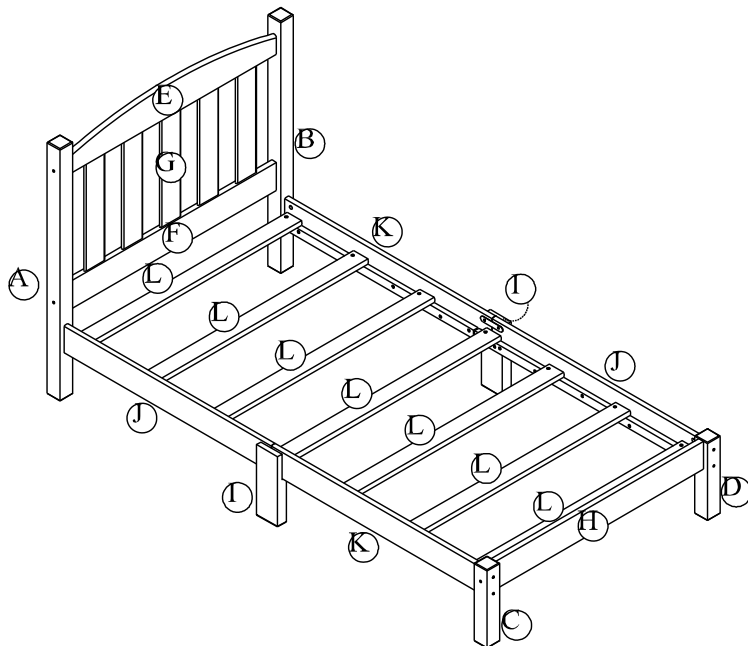

# TWIN BED DA6108WC

## PARTS LIST

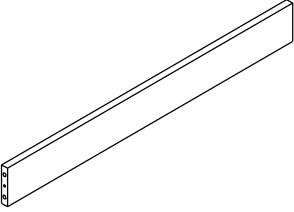
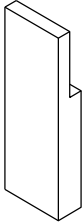
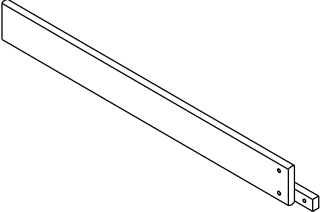
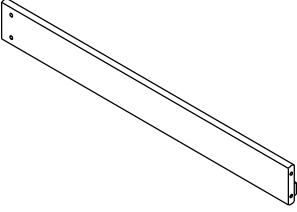
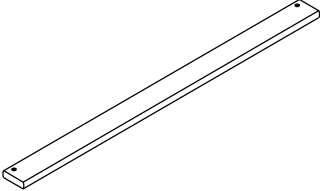
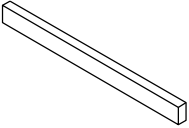
<b>G</b> 	<b>H</b> 	<b>I</b> 
HEADBOARD SLAT 5 PCS	FOOTBOARD CROSS 1 PC	SUPPORT POST 2 PCS
<b>J</b> 	<b>K</b> 	<b>L</b> 
SIDE RAIL 2 PCS	SIDE RAIL 2 PCS	SLAT 7 PCS
<b>M</b> 		
SPACE BLOCK 2 PCS		

# TWIN BED DA6108WC

## STEP 1

Insert stoppers (10) and headboard slats (G) into each hole of the headboard bottom cross (F) and push down until firmly in place. Slide the headboard top cross (E) onto the headboard slats (G).

Insert wood dowels (4) into the ends of top cross (E) and bottom cross (F).

Attach headboard posts (A and B) to top cross (E) and bottom cross (F) with wood dowels (4) and wood joint connectors (3).

Insert wood dowels (4) into the ends of footboard cross (H). Attach footboard posts (C and D) to footboard cross (H) with wood dowels (4) and wood joint connectors (3).

Use Allen key (9) to tighten all wood joint connectors.

NOTE: Top cross (E) and bottom cross (F) may require that they be pulled closer together or further apart in order to allow wood dowels (4) to align with holes in headboard posts (A and B).

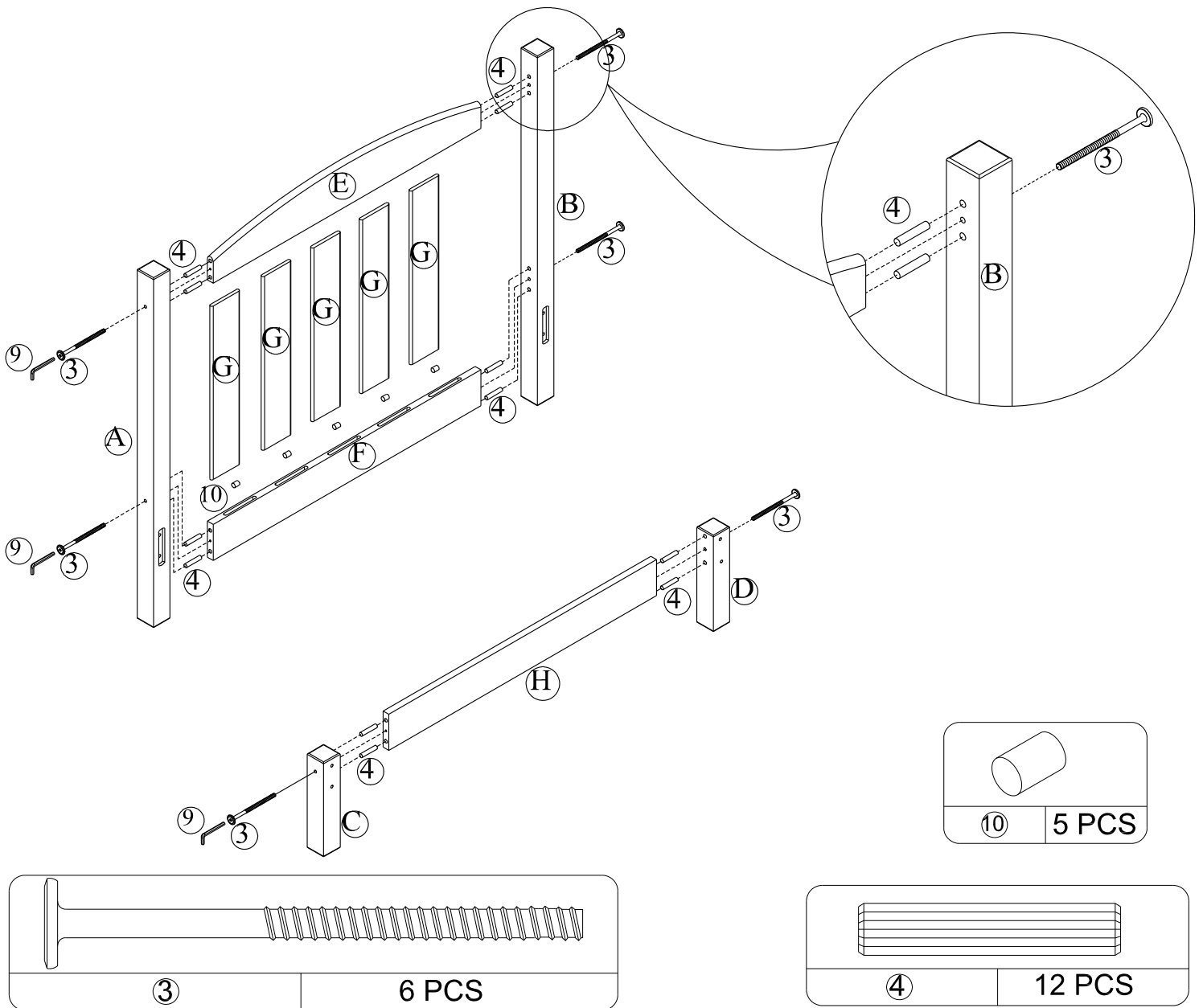

# TWIN BED DA6108WC

## STEP 2

Attach side rails (J and K) to headboard posts (A and B) with joint connectors (1) and barrel nuts (2).

Use Allen key (9) to tighten joint connectors (1).

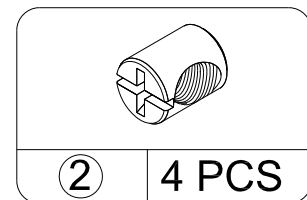
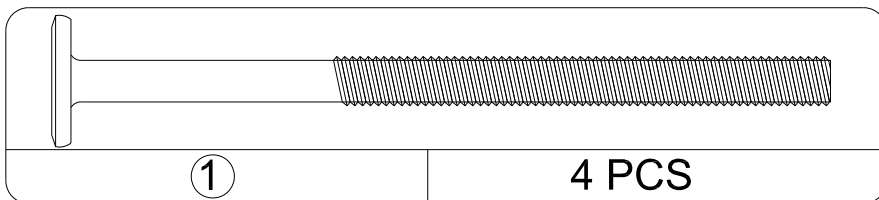
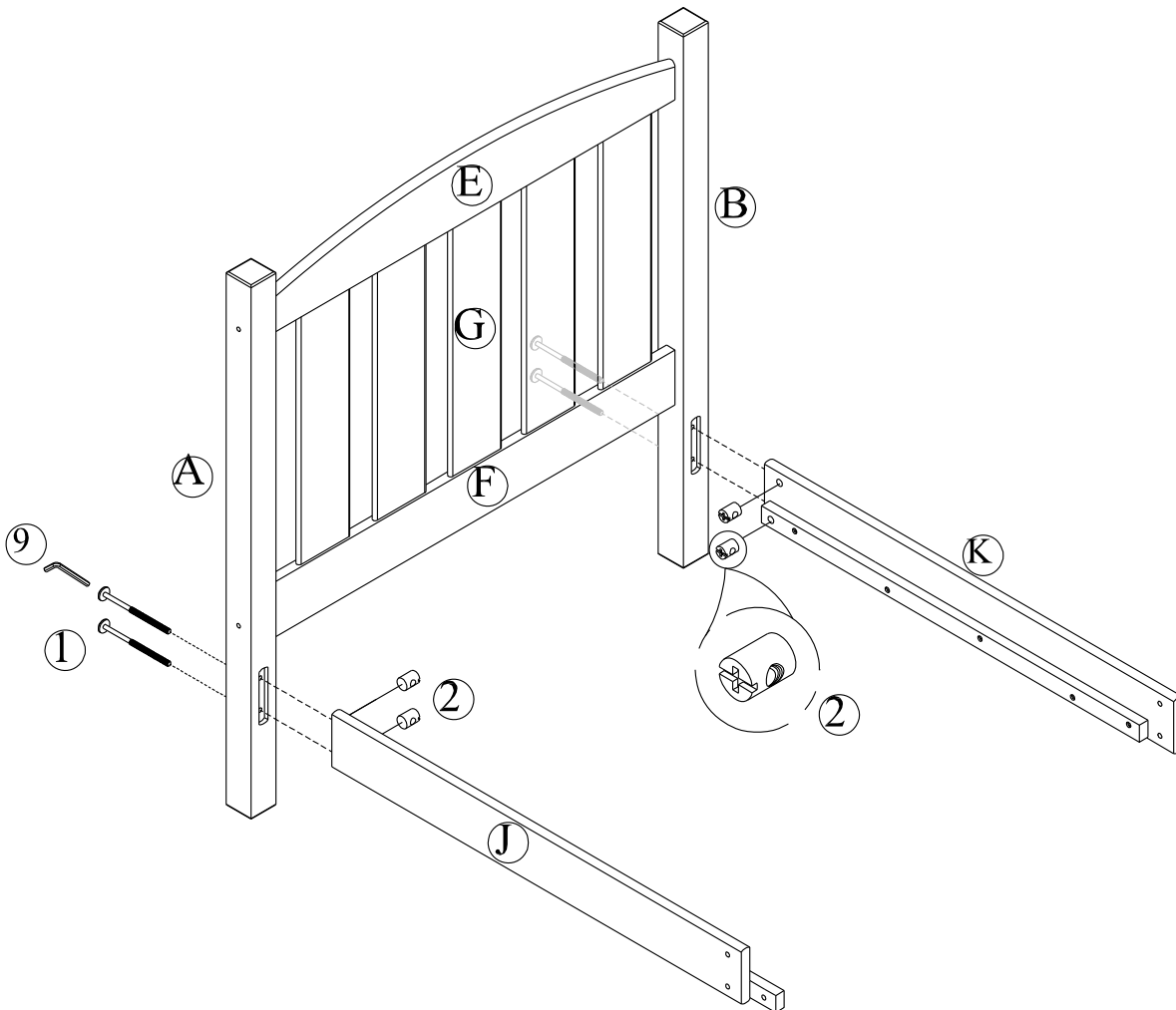

# TWIN BED DA6108WC

## STEP 3

Attach the other side rails (J and K) to support posts (I) with joint connectors (5).

Further secure the side rails using metal plates (7) and joint connectors (6) as shown below.

Attach the side rails (J and K) to footboard posts (C and D) with joint connectors (1) and barrel nuts (2).

Use Allen key (9) to tighten all joint connectors.

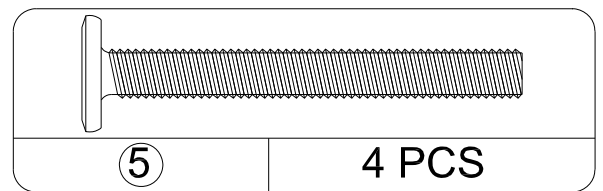
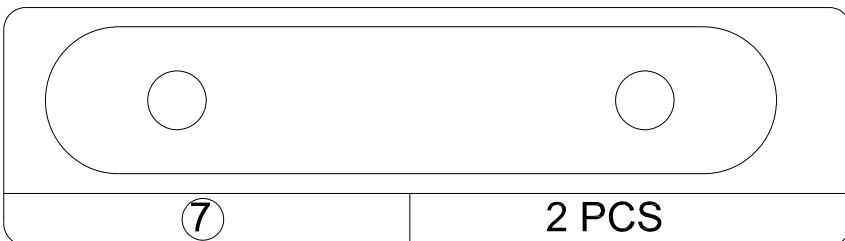
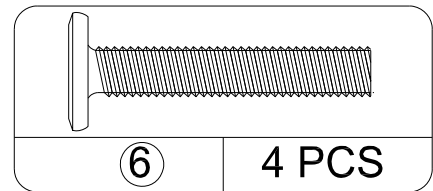
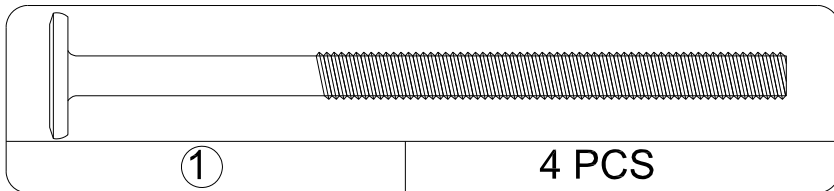
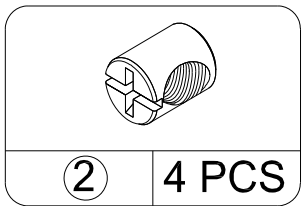
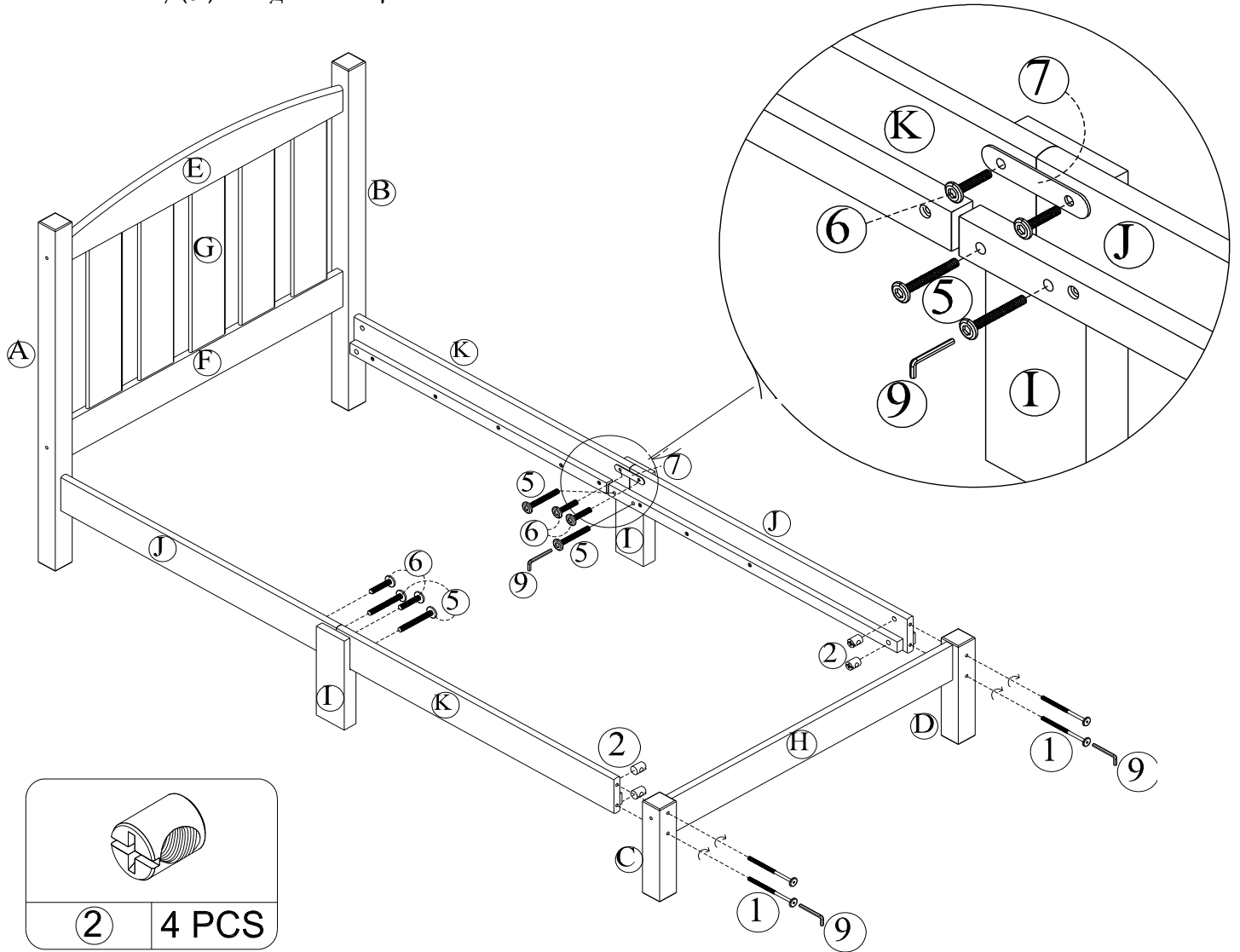



# TWIN BED DA6108WC

## STEP 4

Attach one slat (L) to side rails (J and K) as close to headboard as possible with flat head screws (8). Attach the remaining slats (L) to the side rails (J and K) with flat head screws (8) using space blocks (M) to space them out evenly. on both sides.

NOTE: Tighten all flat head screws (8) with a Phillips head screwdriver (not included).

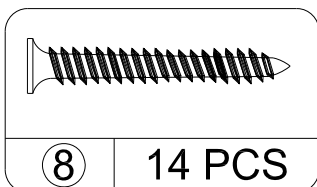
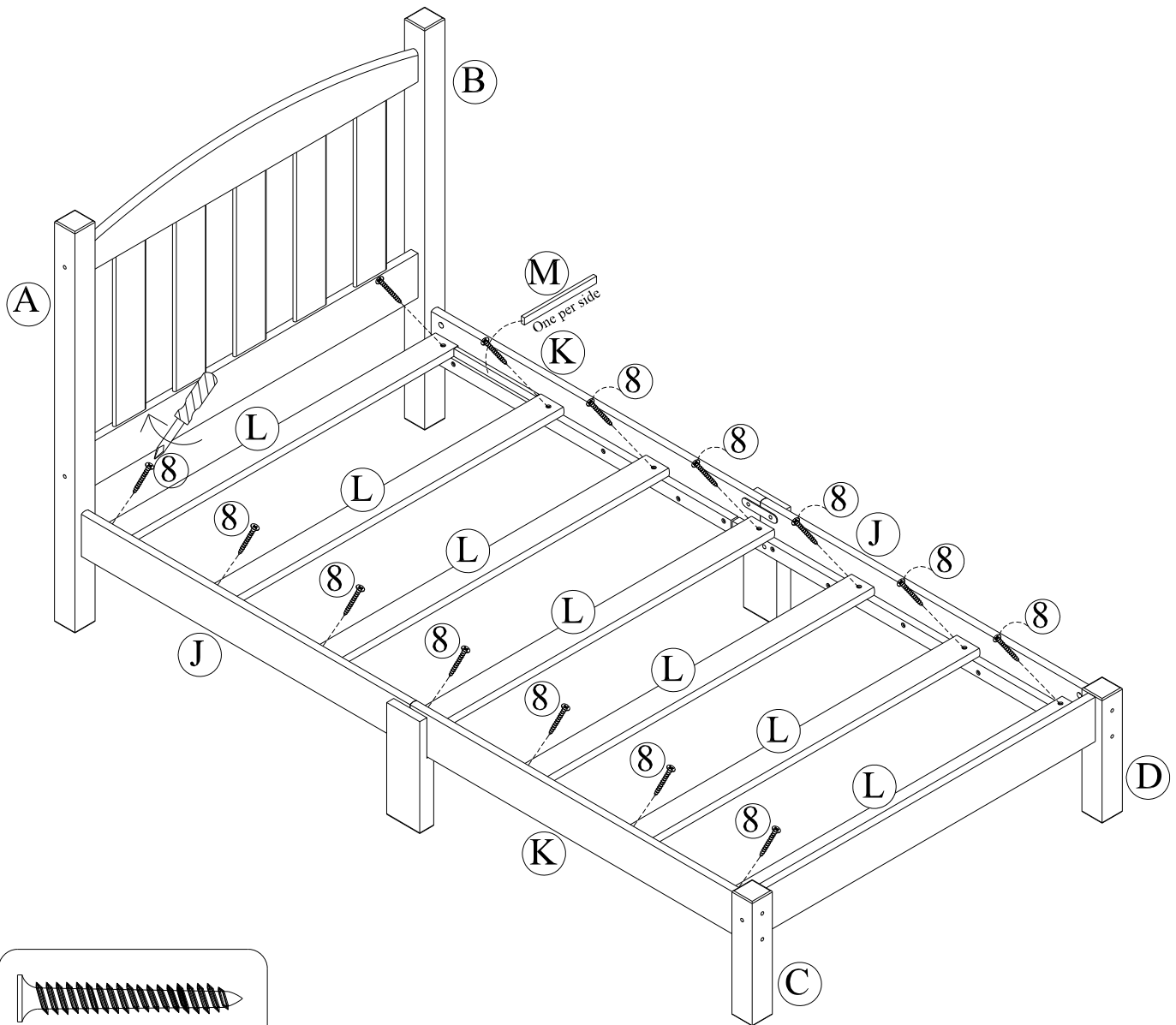

# TWIN BED DA6108WC



**CAUTION:** This unit is intended for use only with the products and/or maximum weights indicated. Use with other products and/or products heavier than the maximum weights indicated may result in instability or cause possible injury.

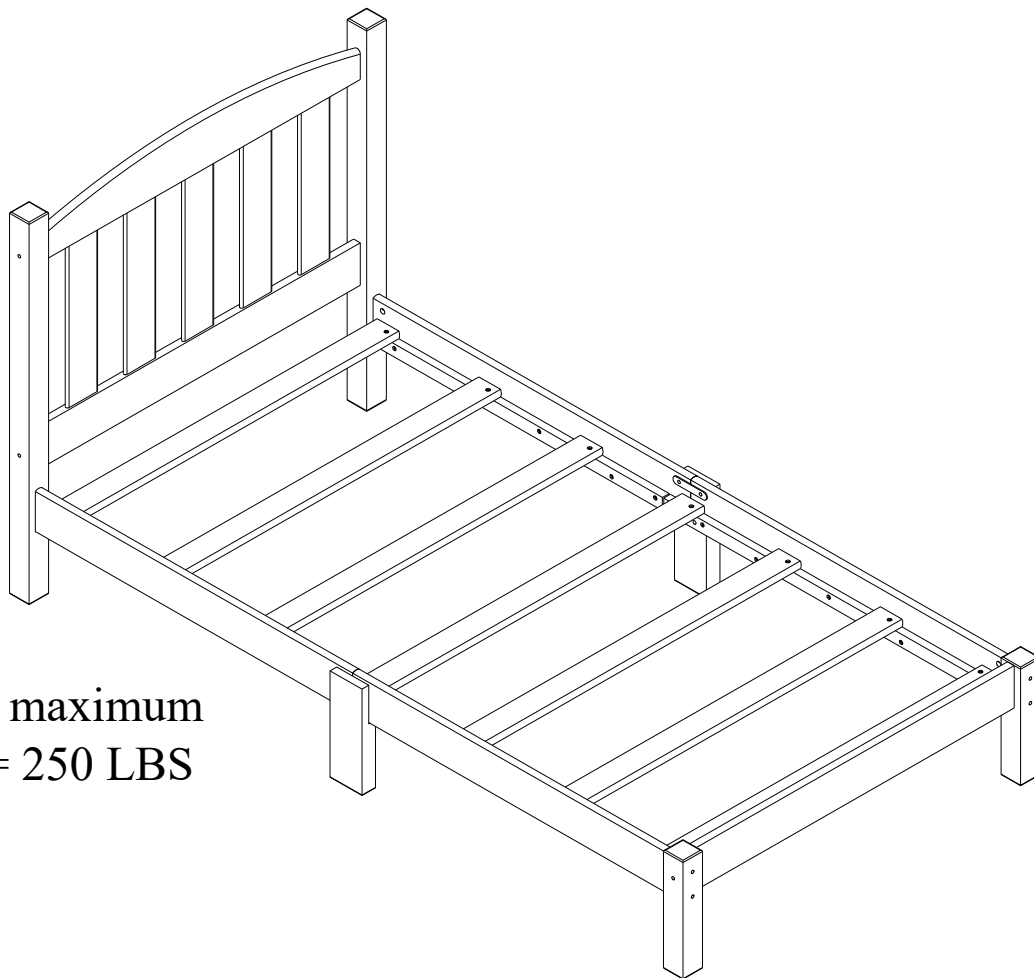

Intended maximum  
Weight = 250 LBS

That's it ! You've finished assembling your twin bed.

**DO NOT RETURN PRODUCT TO THE STORE.**  
If a part is missing or damaged, contact our customer service department. We will replace the part **FREE** of charge.



**Tel # : 1-800-295-1980**  
**E-Mail: [das@dorel.com](mailto:das@dorel.com)**  
**Fax #: 514-353-7819**

# Customer Service

**PLEASE DO NOT RETURN THIS PRODUCT TO THE STORE**

**PLEASE CONTACT CUSTOMER SERVICE REPRESENTATIVES AT THE FOLLOWING NUMBERS SHOULD THERE BE ANY MISSING OR DEFECTIVE PART(S).**

Customer Service Phone Number 1-800-295-1980

Email: [das@dorel.com](mailto:das@dorel.com)

Customer Service Fax Number 514-353-7819

Request Date:

Name:

Shipping Address:

Street & Number:

City & State:

Zip Code:

Day Time Phone Number:

(including area code)

Date & Place of Purchase:

Part(s) description and quantity: (Please be sure to list model number or SKN number)

Customer Service Representative Mailing Address:

Customer Service Department No. 413, 12345 Albert-Hudon Boulevard, Suite 100, Montreal, QC, Canada, H1G 3L1